



accessus

SUSPENDED PLATFORM FOR CHIMNEYS

id **innovative** sistemi di prevenzione  
50 m di altezza



“ Let’s leave  
the **children**  
a better world



INDEX \_\_\_\_\_ 3

WHO WE ARE \_\_\_\_\_ 4

Mission \_\_\_\_\_ 4  
Vision \_\_\_\_\_ 5  
Values \_\_\_\_\_ 5

SUSPENDED PLATFORM FOR CHIMNEYS \_\_\_\_\_ 6

Detachable circular platform model Komplet \_\_\_\_\_ 8  
Rectangular platform model Basic Cube \_\_\_\_\_ 10  
Removable platform model Robot \_\_\_\_\_ 12  
Manual angle platform \_\_\_\_\_ 14  
Basic double cabin turntable \_\_\_\_\_ 14

PPES FOR WORKING AT HEIGHT \_\_\_\_\_ 16

ACCESUS SERVICES \_\_\_\_\_ 18

**id.inee**vita  
sistemi di prevenzione anticaduta

**1** At Accessus we are specialists in the development and manufacture of equipment for working at height and suspended platforms with more than 10 years of experience in the development of equipment for the industrial sector.



**3** We work in close contact with our customers and health and safety responsibilities to adapt and develop special equipments and procedures.



**2** We offer platforms for work inside an outside industrial chimneys for different works ; maintenance and inspection , painting and repairing , demolition and asbestos removal.



**4** Accessus works with ease in all kinds of environments and activities, as well as with all kinds of interlocutors.  
We are recognized national leaders, with a strong international projection, by our users, employees, clients and suppliers in the suspended platforms and work at height sector.

**5** **Passion:** committed with heart and mind.  
**Innovation:** we constantly study ways to improve processes and products.  
**Quality:** we seek excellence.  
**Corporate Social Responsibility:** committed to the environment.  
**Customer Service:** aimed at satisfying our customers through our products and services.  
**Flexibility:** easily adaptable to changes.  
**Permanent training:** we are committed to the continuous training of our staff.

DETACHABLE CIRCULAR PLATFORM MODEL KOMPLET

DETACHABLE CIRCULAR PLATFORM MODEL KOMPLET

Detachable circular platform model Komplet for works inside chimneys.

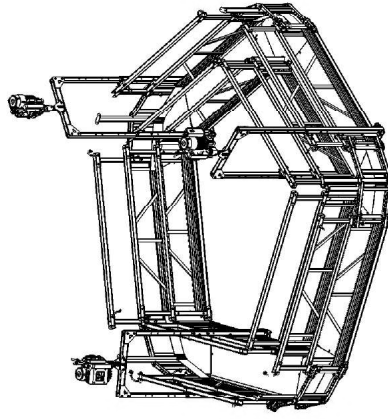
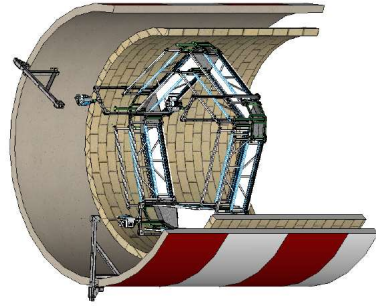

Detachable YES



Number of lifts: 3 x 500 kg electric



Regulations: 2006/42/CE, EN 1808



Maximum height: unlimited



Certified for people YES



Dimensions: diameter 2,1 to diameter 7 meters.



Made of aluminium



Passage through manhole 700 mm



Rectangular platform model Basic Cube removable for working inside chimneys

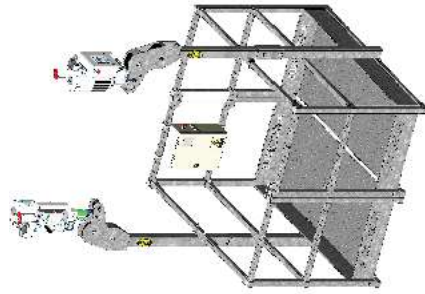

Detachable YES



Number of lifts: 2 x 500 kg electric

Passage through manhole  
670 - 750 mm



Certified for people YES

Dimensions: 1,4 x 0,8 meters  
to 1,4 x 1,6 meters



Made of steel



Regulations: 2006/42/CE, EN 1808



REMOVABLE PLATFORM MODEL ROBOT

Removable platform model robot for automatic demolition inside the chimney  
 Compatible with Husqvarna DXR1 40 and Brokk 110 robots



REMOVABLE PLATFORM MODEL ROBOT

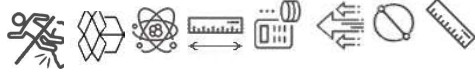
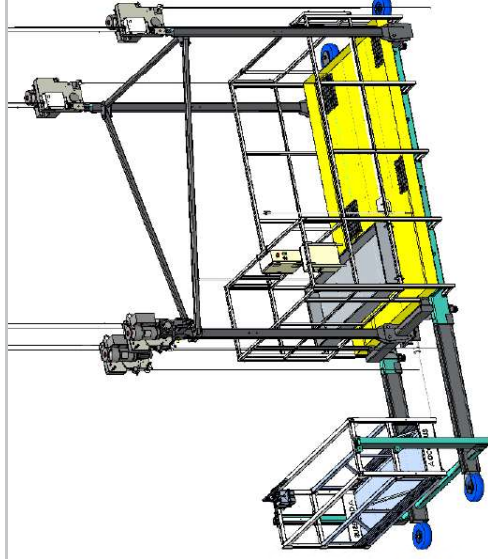

Certified for people YES

Detachable YES

Made of steel

Maximum height : unlimited

Regulations: 2006/42/CE, EN 1808









Number of lifts : 4 x 1000 kg electric

Passage through manhole  
1,5m

Dimensions : Ø 5,5 to 9







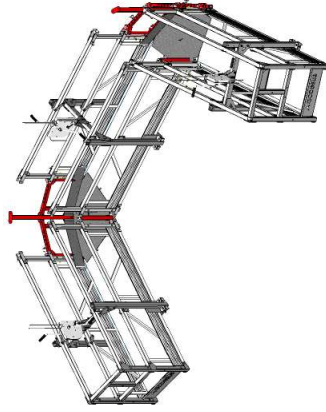



Manual angle platform for external chimney demolition

-  Made of aluminium
-  Passage through manhole 700mm
-  Detachable YES
-  Maximum height : unlimited
-  Certified for people YES
-  Chimney dimensions, any dimension
-  Regulations: 2006/42/CE, EN 1808
-  Number of lifts: 3 x 400 kg manual



**id. lineeVita**  
sistemi di prevenzione anticaduta

Basic double platform cabin turntable for interior work on conical chimneys

-  Made of steel
-  Number of lifts : 2 x 500 kg (electric)
-  Detachable YES
-  Maximum height : unlimited
-  Certified for people YES
-  Chimney dimensions: 4 to 7 meters
-  Regulations: 2006/42/CE, EN 1808
-  Passage through manhole  
700mm

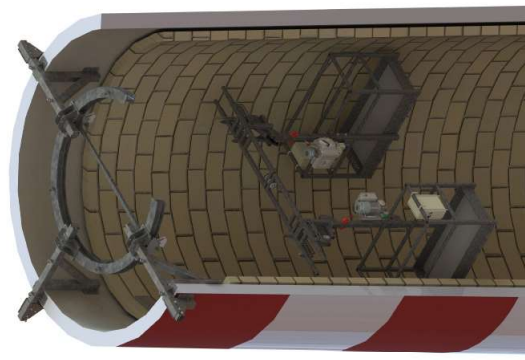



Several years of experience in the sector has allowed Accessus to develop a very complete range of PPEs that perfectly adjusts to the needs of the wind energy sector. Take a look at the most demanded ones:

### 1 Harnesses



**A71 E**  
Rotating positioning belt and automatic closures harness.



**A73**  
High-class harness for suspended works.

140kg

### 2

#### Lanyards and anchor points



**PAT 900**  
20 mm wide polyester strap anchor point.  
22 kN and 6 available lengths:  
0.3, 0.6, 0.8, 1.2, 1.5 and 2 m.



**PAC 410**  
Steel sling with 8 mm grommets to connect with a carabiner.  
15 kN and 3 available lengths:  
0.5, 1 and 2 m.



**612404-020**  
2 m elastic double fall arrest lanyard.

### 3

#### Fall arrest accessories



**CT 205**  
Anti-trauma tape to prevent accidents and relieve groin pressure in falls from height.



**PH2**



#### Tool holders

Velcro (PH1) or elastic (PH2) wrist tool holder, retractable (PH3) tool holder and sling-type (PH040-BT001) tool holder.  
Maximum load capacity: from 0.5 to 2 Kg.



**PH3**

### 4

#### Tool & PPEs Bags



**BLS 11K**  
PPEs PVC bag with double adjustable strap closure.  
60x30x30 cm.  
33 l capacity.



**BLS 502**  
Canvas tool bag with outer and inner pockets.  
40x30x30 cm.  
25 l capacity.



In addition to manufacturing suspended platforms and offering the safest and most specialized PPEs for working at height, Accessus is also

characterized by offering a set of value-added services to our customers:



**Custom designs:**

We offer technical field studies reports with case studies offers, we provide the customer with all the detailed technical sheets, user's manuals and certifications of our products and try to accomplish all our client's needs.



**Renting:**

The rental of suspended platforms equipment means an important part of Accessus activity.



**Accessus Global Training:**

Accessus offers all kind of training courses to serve our clients wherever is needed: commercial trainings to distributors, user training for the correct use of our platforms and training programs for equipment maintainers.



**Maintenance & After Sales:**

In Accessus you'll find a strong After Sales team made of qualified technicians and you'll also be able to get a maintenance and warranty certificate for each platform you get.



**Assembly & Set Up:**

We have our own trained and experienced staff for assembling and setting up our Modulare suspended platforms in our facilities or outdoors.



**R&D:**

Accessus Technical Department is continuously developing new prototypes in order to improve our own products for our customers.

